

DECAL KIT "USA"  
 SCHILDERSATZ "USA"  
 JEU DE PLAQUES "USA"

from No / up to No  
 WFN5RUD###2029116  
 WFN5RUD###2029181

Figure  
 Bild 99707785896  
 Figure

**TADANO**  
 2830-06

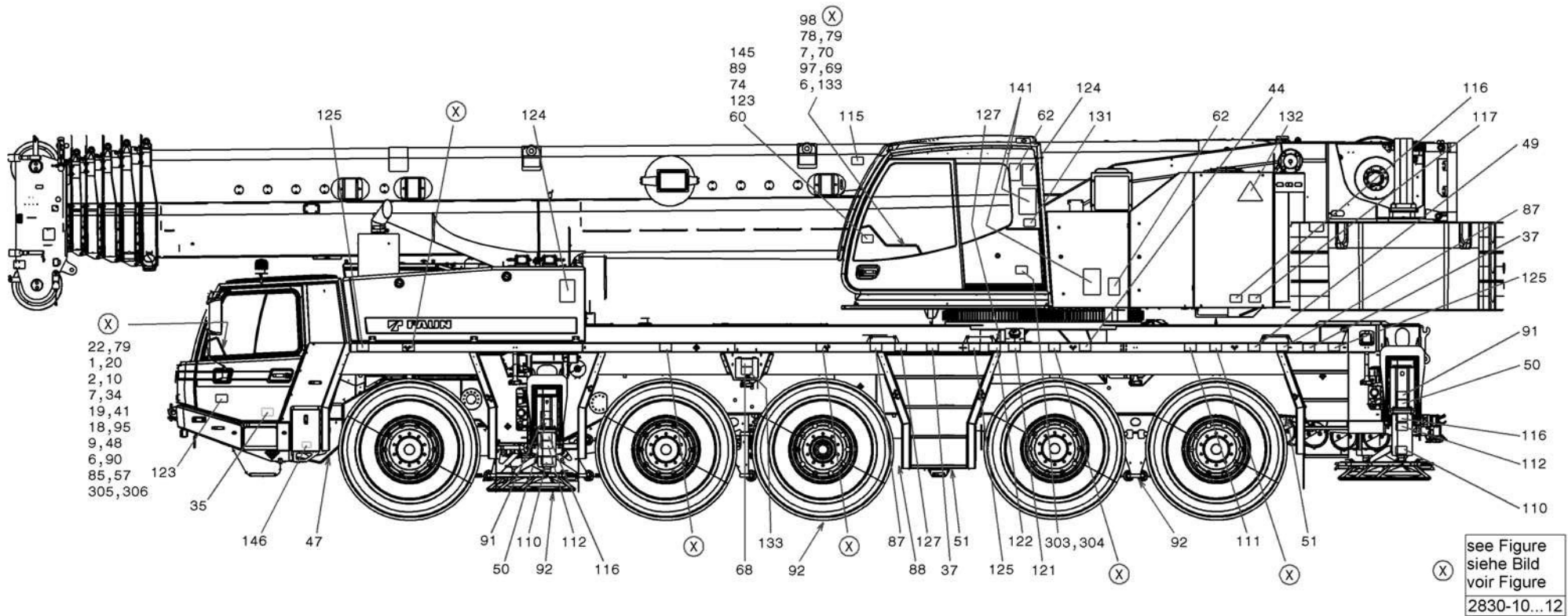

DECAL KIT "USA"  
SCHILDERSATZ "USA"  
JEU DE PLAQUES "USA"

from No / up to No  
WFN5RUD###2029116  
WFN5RUD###2029181

Figure  
Bild 99707785896  
Figure

**TADANO**  
2830-06

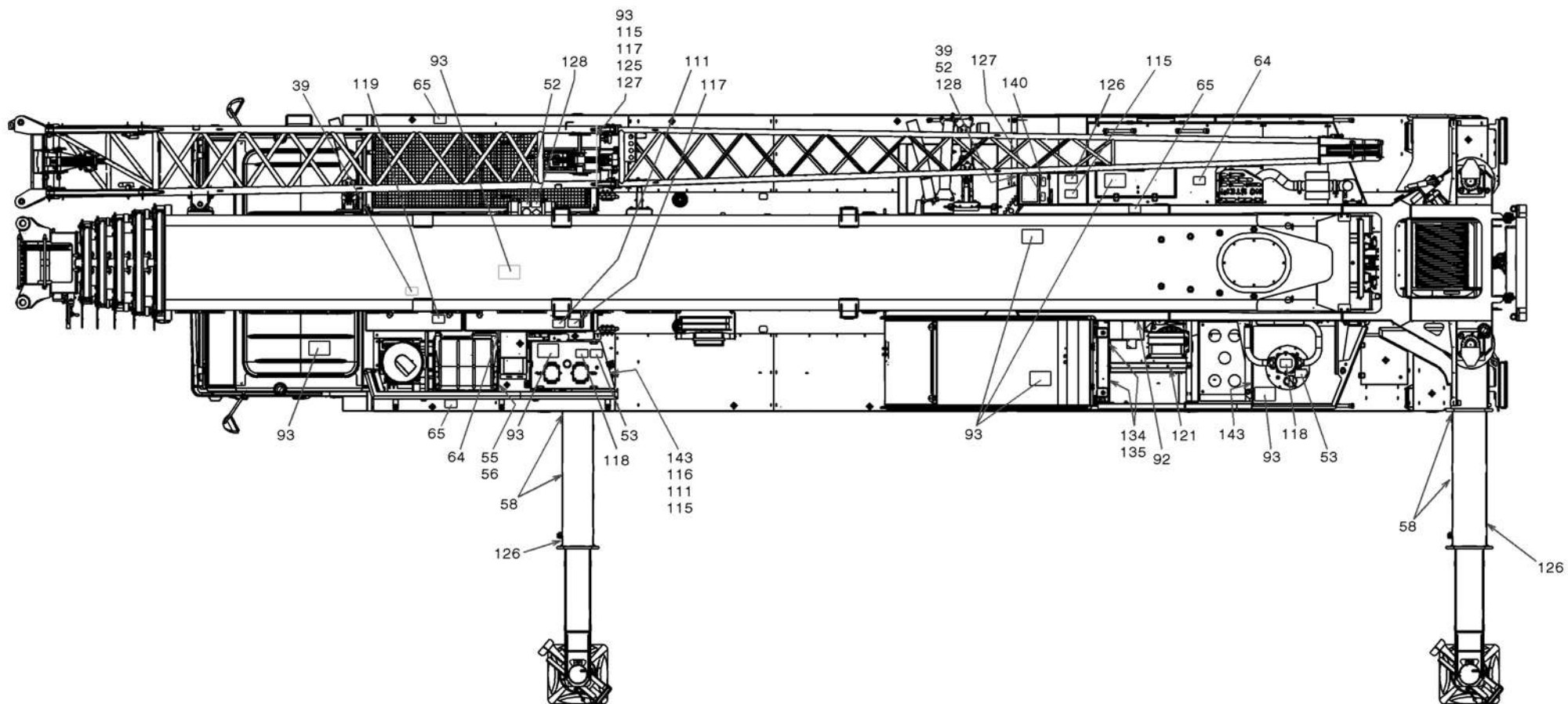

DECAL KIT "USA"  
SCHILDERSATZ "USA"  
JEU DE PLAQUES "USA"

from No / up to No  
WFN5RUD###2029116  
WFN5RUD###2029181

Figure  
Bild 99707785896  
Figure

**TADANO**  
2830-06

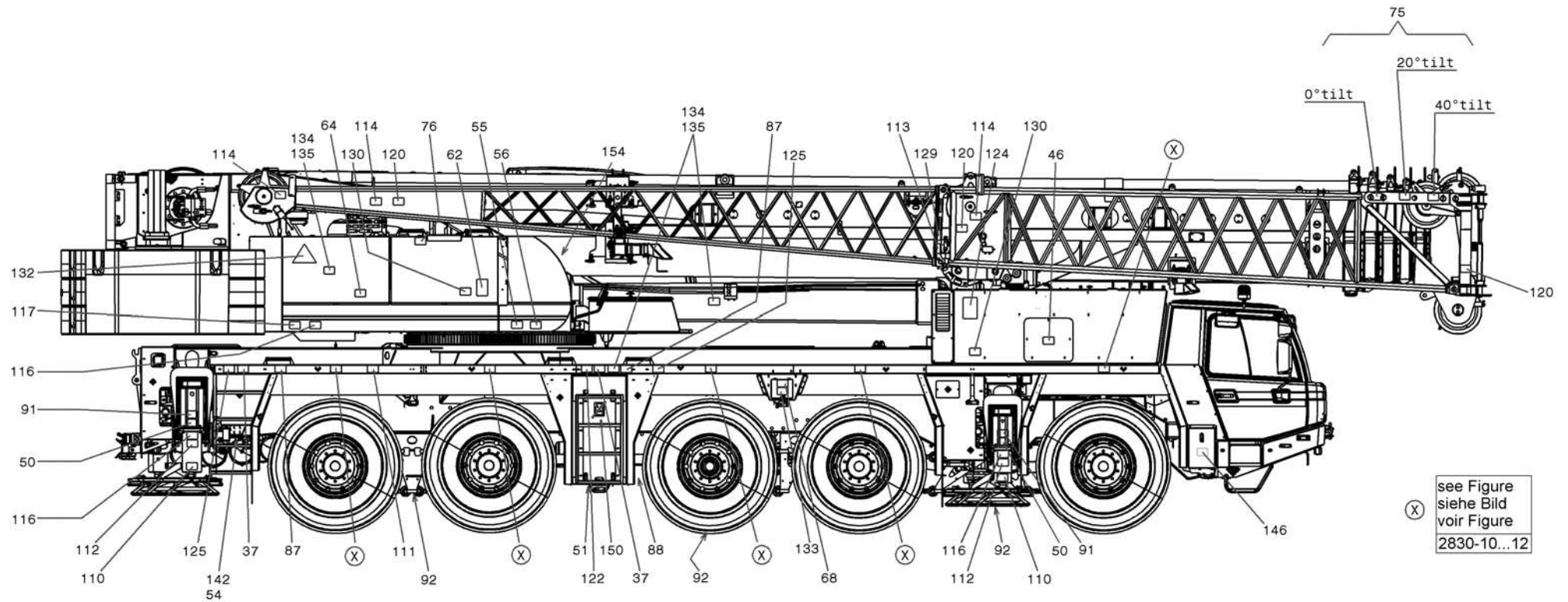

DECAL KIT "USA"  
SCHILDERSATZ "USA"  
JEU DE PLAQUES "USA"

from No / up to No  
WFN5RUD###2029116  
WFN5RUD###2029181

Figure  
Bild 99707785896  
Figure

**TADANO**  
2830-06

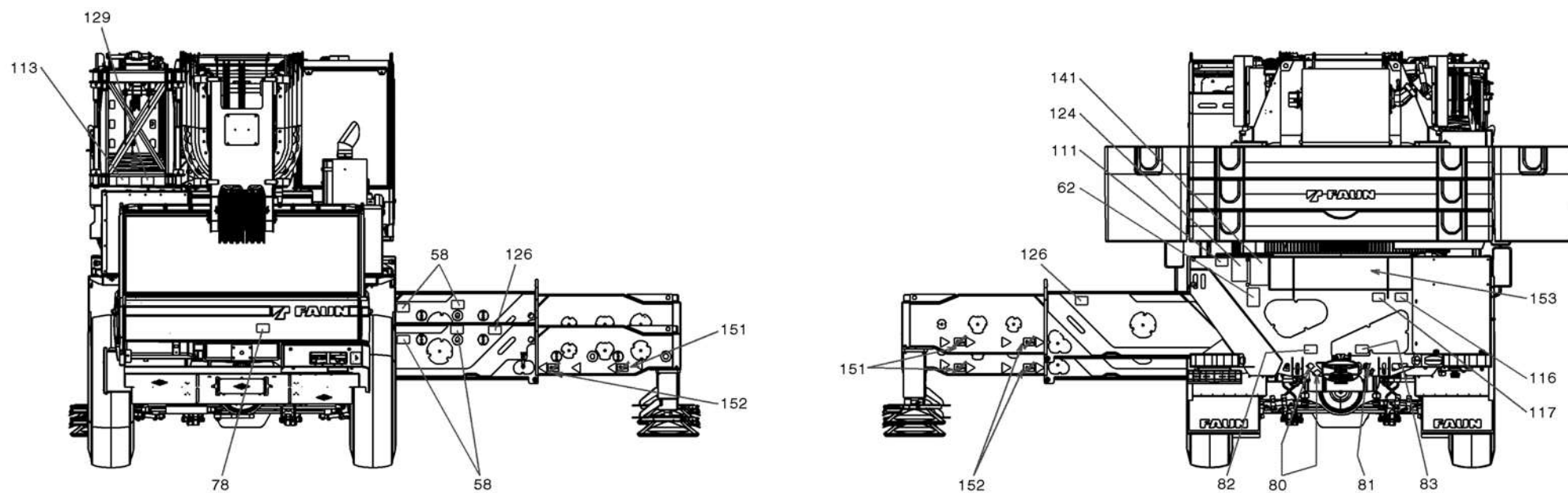



DECAL KIT "USA"  
 SCHILDERSATZ "USA"  
 JEU DE PLAQUES "USA"

from No / up to No  
 WFN5RUD###2029116  
 WFN5RUD###2029181

Figure  
 Bild 99707785896  
 Figure

**TADANO**  
 2830-06

SPEED - CHART				
Tires 16.00R25 / 20.5R25				
Gear	Off-Road		On-Road	
	mph	km/h	mph	km/h
1 st	2	3	4	6
2 nd	2	3	4	7
3 rd	2	4	5	8
4 th	2	4	6	10
5 th	3	5	7	12
6 th	4	7	9	15
7 th	5	8	11	18
8 th	6	9	13	21
9 th	7	11	16	26
10 th	9	14	19	31
11 th	11	17	24	38
12 th	12	20	29	46
13 th	15	24	35	56
14 th	19	30	42	68
15 th	22	35	50	80
16 th	26	42	53	85
1 st RW	2	3	4	6
2 nd RW	2	3	4	7

DO NOT RUN THE ENGINE OVER 2000 rpm 99707785935

90

**MAX. JACK FORCE DURING CRANE OPERATION:**  
**109 TONS (US)** 99707785934

91

0°TILT 99707785927
20°TILT 99707785927
40°TILT 99707785927

75

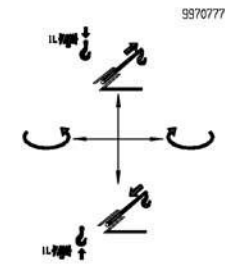
9970777801

98

OPERATING AIR PRESSURE  
**220 PSI** 7741386

51

**18.37 ft**

151

**27.23 ft**







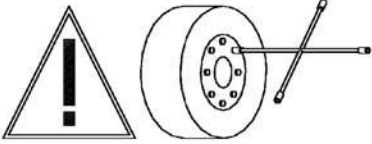
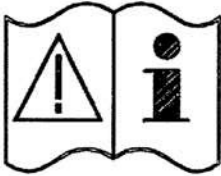
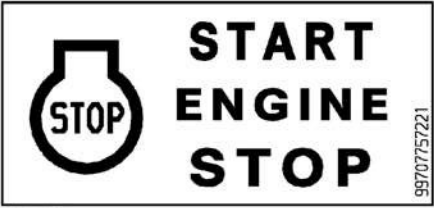

152

DECAL KIT "USA"  
 SCHILDERSATZ "USA"  
 JEU DE PLAQUES "USA"

from No / up to No  
 WFN5RUD###2029116  
 WFN5RUD###2029181

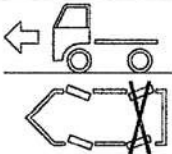
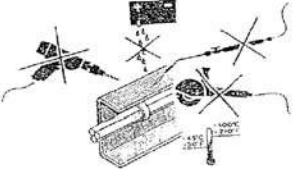
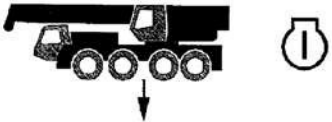
Figure  
 Bild 99707785896  
 Figure

**TADANO**  
 2830-06

 <p>≈ 50/100/200/...km      ≈ 30/60/120/...miles</p> <p>9970715238</p> <p>1</p>	 <p>SEE OPERATORS MANUAL</p> <p>7741359</p> <p>2</p>	 <p>997075221</p> <p>6</p>	 <p>7741364</p> <p>ENGINE SPEED CONTROL</p> <p>7</p>
 <p>PARKING BRAKE</p> <p>7757220</p> <p>9</p>	<p><b>WARNING</b></p>  <p>HAZARDOUS CONDITION      CAN CAUSE VEHICLE HANDLING PROBLEMS      DIFFERENTIAL LOCK MUST ONLY BE ENGAGED      IN OFF - ROAD ROUGH TERRAIN CONDITIONS</p> <p>7757245</p> <p>10</p>	<p><b>WARNING</b></p>  <p>7741365</p> <p>LOCK THE REAR AXLE STEERING SYSTEM      WHEN TRAVELING ON ROAD OR WITH DOLLY</p> <p>18</p>	<p><b>CAUTION</b></p>  <p>PLASTIC BRAKE SYSTEM PIPES      BE CAREFUL WHEN WELDING DRILLING AND MOUNTING</p> <p>7741399</p> <p>19</p>
<p><b>CAUTION</b></p>  <p>VEHICLE LOWERS      ONLY WHEN ENGINE IS RUNNING</p> <p>7757244</p> <p>20</p>	<p><b>WARNING</b></p>  <p>DO NOT STAY UNDER OR ON      VEHICLE WHEN LOWERING</p> <p>7741356</p> <p>22</p>	<p><b>CAUTION</b></p>  <p>DO NOT REMAIN IN CAB WHEN      CRANE IS OPERATING</p> <p>7757246</p> <p>34</p>	<p><b>CAUTION</b></p>  <p>ENGAGE PARKING HANDBRAKE BEFORE      LEAVING CAB.</p> <p>7741361</p> <p>35</p>

DECAL KIT "USA"  
 SCHILDERSATZ "USA"  
 JEU DE PLAQUES "USA"

from No / up to No  
 WFN5RUD###2029116  
 WFN5RUD###2029181

Figure  
 Bild 99707785896  
 Figure

**TADANO**  
 2830-06

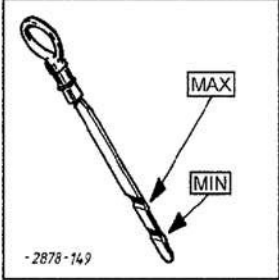
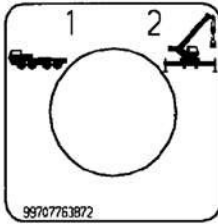
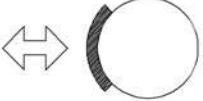



<p><b>WARNING</b>        STOP!        NO ACCESS FOR UNAUTHORIZED PERSONNEL</p>  <p>7757258</p> <p>37</p>	 <p>-2878-149</p> <p>39</p>	 <p>99707763872</p> <p>41</p>	<p><b>NOTICE</b>        TEST CONNECTORS        M4        FOR HYDRAULIC SYSTEM        SEE OPERATORS MANUAL        FOR INSTRUCTIONS</p> <p>99707785926</p> <p>44</p>
<p><b>NOTICE</b>        TEST CONNECTORS        M3        FOR HYDRAULIC SYSTEM        SEE OPERATORS MANUAL        FOR INSTRUCTIONS</p> <p>99707780259</p> <p>46</p>	<p><b>NOTICE</b>        TEST CONNECTORS        M1 + M2        FOR STEERING SYSTEM        SEE OPERATORS MANUAL        FOR INSTRUCTIONS</p> <p>99707757000</p> <p>47</p>	 <p>AIR BRAKE PRESSURE:        120 - 145 PSI</p> <p>99707780263</p> <p>48</p>	<p><b>NOTICE</b>        TEST CONNECTOR        M5        FOR STEERING SYSTEM        SEE OPERATORS MANUAL        FOR INSTRUCTIONS</p> <p>99707757002</p> <p>49</p>
<p><b>WARNING</b></p> <p>INSTALL ALL PINS IN EACH OUTRIGGER,        OUTRIGGER PAD AND JIB BEFORE STARTING        TO TRAVEL</p> <p>7741394</p> <p>50</p>	<p>OPERATING AIR        PRESSURE        220 PSI</p> <p>7741386</p> <p>51</p>	<p><b>NOTICE</b>        COOLING FLUID        SEE OPERATORS MANUAL        FOR INSTRUCTIONS</p> <p>7741396</p> <p>52</p>	<p><b>NOTICE</b>        HYDRAULIC FLUID        SEE OPERATORS MANUAL        FOR INSTRUCTIONS</p> <p>7741397</p> <p>53</p>

DECAL KIT "USA"  
 SCHILDERSATZ "USA"  
 JEU DE PLAQUES "USA"

from No / up to No  
 WFN5RUD####2029116  
 WFN5RUD####2029181

Figure  
 Bild 99707785896  
 Figure

**TADANO**  
 2830-06

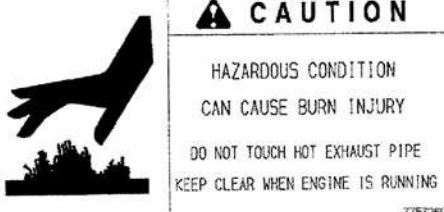
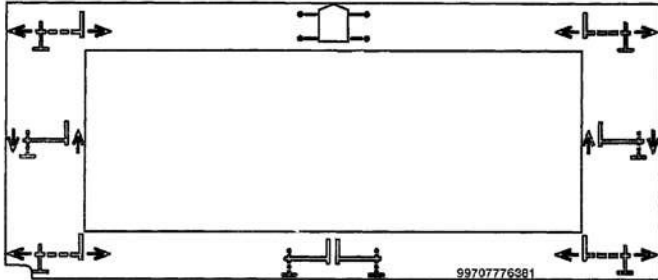
 <p style="text-align: right;">57</p>	 <p style="text-align: center;">58</p>	<p style="text-align: center;"><b>NOTICE</b></p> <p style="text-align: center;">TEST CONNECTORS FOR AIR BRAKE SYSTEM      A - H      SEE OPERATORS MANUAL      FOR INSTRUCTIONS 3970778592E</p> <p style="text-align: center;">54</p>	
 <p style="text-align: center;">62</p>	 <p style="text-align: center;">146</p>	 <p style="text-align: center;">64</p>	<p style="text-align: center;">EXTERNAL BATTERY      STARTING      PLUG SOCKET      24V / DC 7741391</p> <p style="text-align: center;">55</p>
	 <p style="text-align: center;">60</p>	<p style="text-align: center;">BATTERY CHARGING      PLUG SOCKET      24V / DC 7741392</p> <p style="text-align: center;">56</p>	



DECAL KIT "USA"  
 SCHILDERSATZ "USA"  
 JEU DE PLAQUES "USA"

from No / up to No  
 WFN5RUD###2029116  
 WFN5RUD###2029181

Figure  
 Bild 99707785896  
 Figure

**TADANO**  
 2830-06





 <p><b>WARNING</b></p> <p><b>DO NOT STEP HERE</b></p> <p>7757214</p> <p>65</p>	<p><b>OUTRIGGER CONTROL BOX</b></p> <p>7757213</p> <p>68</p>	 <p><b>WARNING</b></p> <p>STEERING FUNCTIONS ONLY WHILE ENGINE IS RUNNING</p> <p>7757267</p> <p>69</p>	<p>FREE</p>  <p>7757286</p> <p>SWIMS</p>  <p>LOCKED</p> <p>70</p>	
 <p><b>WARNING</b></p> <p>HAZARDOUS CONDITION CAN CAUSE SEVERE INJURY ENSURE JIB PIVOT PINS ARE INSTALLED AT BOOM HEAD BEFORE DISCONNECTING JIB FROM STOWING BRACKET</p> <p>7757337</p> <p>113</p>	<p><b>SWING BRAKE</b></p>  <p>7757262</p> <p>74</p>	 <p><b>WARNING</b></p> <p>HAZARDOUS CONDITION CAN CAUSE SEVERE INJURY USE A TAGLINE TO PREVENT RAPID SURING OF JIB FROM BOOM WHEN JIB IS RELEASED AT STOWING BRACKET</p> <p>7757338</p> <p>114</p>	 <p><b>LADDER POSITION</b></p> <p>99707757224</p> <p>76</p>	
<p><b>ON</b></p> <p>99707757237</p> <hr/> <p><b>OFF</b></p> <p>99707757237</p> <p>77</p>	<p><b>12V DC</b></p> <p>7757241</p> <p>78</p>	<p><b>24V DC</b></p> <p>7757240</p> <p>79</p>	<p><b>24V / DC</b></p> <p>99707757231</p> <p>80</p>	 <p><b>ANTI-LOCK SYSTEM 24V / DC</b></p> <p>99707757234</p> <p>81</p>







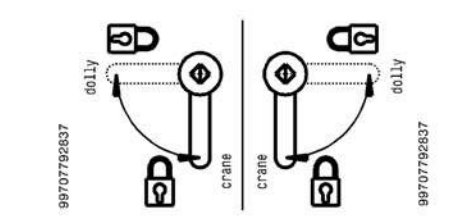
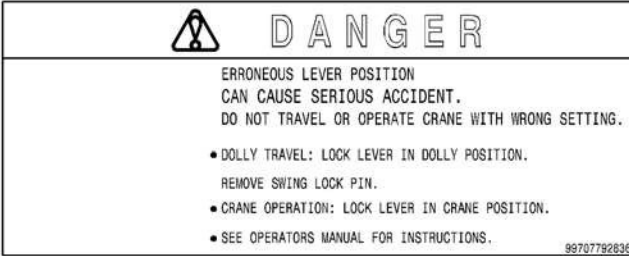

DECAL KIT "USA"  
 SCHILDERSATZ "USA"  
 JEU DE PLAQUES "USA"

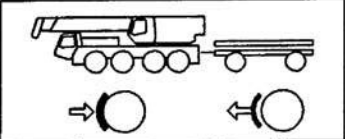
from No / up to No  
 WFN5RUD###2029116  
 WFN5RUD###2029181

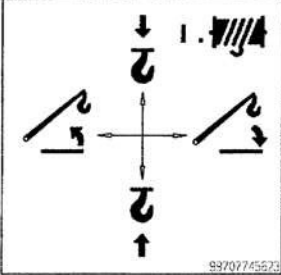
Figure  
 Bild 99707785896  
 Figure

**TADANO**  
 2830-06

 <p>82</p>	 <p>83</p>	 <p>135</p>	
<p><b>FASTEN SEAT BELT</b></p> <p>85 7757227</p>	<p><b>HANDHOLD</b></p> <p>87 7757226</p>	 <p>134</p>	
 <p>88 7757223</p>	 <p>89 7757239</p>		







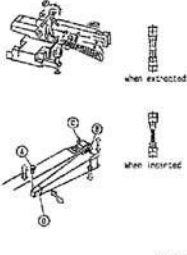

 <p><b>⚠ DANGER</b></p> <p>KEEP CLEAR OF LOWERING OR RAISING BOOM TO AVOID SERIOUS INJURY.</p> <p>7757339</p> <p>115</p>	<p><b>⚠ CAUTION</b></p> <p>DO NOT USE OXYGEN !</p> <p>DO NOT OPERATE UNIT WITHOUT PROPER NITROGEN GAS PRESSURE        RELEASE ALL HYDRAULIC AND GAS PRESSURE BEFORE DISASSEMBLING UNIT        SEE SERVICE INSTRUCTIONS FOR ADDITIONAL INFORMATION</p> <p>7757251</p> <p>92</p>	<p><b>NO STEP</b></p> <p>7757257</p> <p>93</p>	 <p>Test for parking brake:        See operators manual</p> <p>99707757238</p> <p>94</p>
<p><b>⚠ CAUTION</b></p>  <p>BEFORE CHANGING OVER TO OPERATION CONTROLLED FROM THE SUPERSTRUCTURE, MAKE SURE THAT:</p> <ol style="list-style-type: none"> <li>1) TRANSMISSION IS IN NEUTRAL POSITION,</li> <li>2) HANDBRAKES ARE ENGAGED.</li> </ol> <p>99707780260</p> <p>95</p>	<p><b>NOTICE</b></p> <p><b>HYDRAULIC FLUID ONLY</b></p> <p>READ OPERATORS MANUAL BEFORE SERVICING        ALL CYLINDERS MUST BE RETRACTED WHEN CHECKING FLUID LEVEL</p> <p>7757342</p> <p>118</p>	 <p>99707745523</p> <p>97</p>	 <p><b>⚠ DANGER</b></p> <p>SWINGING STRUCTURE        STAY CLEAR TO PREVENT SEVERE PERSONAL INJURY OR DEATH</p> <p>7757341</p> <p>117</p>
 <p><b>⚠ DANGER</b></p> <p>FALLING LOAD OR BOOM CAN CAUSE SEVERE PERSONAL INJURY OR DEATH        STAY CLEAR OF LOAD, BLOCK AND BOOM</p> <p>7757340</p> <p>116</p>	 <p><b>⚠ WARNING</b></p> <p>HAZARD        CAN CAUSE INJURY        KEEP CLEAR OF OUTRIGGER WHILE CRANE IS OPERATING</p> <p>7757334</p> <p>110</p>	 <p><b>⚠ WARNING</b></p> <p>HAZARD        CAN CAUSE INJURY        KEEP CLEAR OF CRANE WHILE SWINGING OR TRAVELING</p> <p>7757335</p> <p>111</p>	 <p><b>⚠ WARNING</b></p> <p>KEEP CLEAR OF MOVING OUTRIGGER TO PREVENT BODILY INJURY.</p> <p>7757336</p> <p>112</p>

DECAL KIT "USA"  
 SCHILDERSATZ "USA"  
 JEU DE PLAQUES "USA"

from No / up to No  
 WFN5RUD####2029116  
 WFN5RUD####2029181

Figure  
 Bild 99707785896  
 Figure

**TADANO**  
 2830-06

 <p><b>WARNING</b></p> <p>ROTATING FAN      KEEP HANDS AWAY      STOP ENGINE TO SERVICE</p> <p>7757343</p> <p>119</p>	<p><b>CAUTION</b></p> <p>JIB HANDLING INSTRUCTIONS      BEFORE OPERATING CRANE OR TRAVELING ON ROAD,      CHECK STOWING PIN (A) AND PIVOT PIN (B).      JIB WILL FALL OFF IF TRUCK IS STARTED WITH      BOTH PINS OUT OF POSITION.      NEVER EXTEND BOOM WHEN BOTH PINS ARE FIRED AT      THE SAME TIME. THE BOOM WILL BE DAMAGED.</p> <p>ATTN: FOR JIB</p> <ol style="list-style-type: none"> <li>1. INSERT TOP AND BOTTOM PIVOT PIN (B).</li> <li>2. EXTRACT STOWING PIN (A).</li> <li>3. DISCONNECT ROPE SOCKET FROM ANCHOR (C).</li> <li>4. MARK AND ALIGN JIB STRAIGHT AHEAD OF BOOM      AND INSERT TOP AND BOTTOM CONNECTING PINS (D).</li> <li>5. SEW ELECTRICAL CONNECTIONS FOR ANCHOR AND ROPE      TALKER DEVICE. (SEE THE HOIST SYSTEM MANUALS).</li> </ol> <p>ATTN: STOW JIB, INSERT STOWING PIN (A) TO SECURE JIB      TO BOOM AND THEN EXTRACT PIVOT PIN (B).      ATTACH ROPE SOCKET TO ANCHOR (C) ONLY AFTER JIB      IS COMPLETELY STOWED.</p>  <p>when extracted</p> <p>when inserted</p> <p>7757344</p> <p>120</p>	<p><b>DIESEL      FUEL</b></p> <p>7757345</p> <p>121</p>	<p><b>DANGER</b></p> <p>HAZARDOUS CONDITION      CAN CAUSE SEVERE INJURY OR DEATH      STAY CLEAR WHEN INFLATING TIRES      ALWAYS USE AN AIR CHUCK AND TIRE CAGE      RIM SIDE OR LOCK RING CAN BLOW OUT</p> <p>1802075796</p> <p>122</p>
<p><b>WARNING</b></p> <p>DO NOT OPERATE THIS CRANE UNLESS</p> <ul style="list-style-type: none"> <li>- YOU ARE TRAINED IN ITS SAFE OPERATION</li> <li>- YOU KNOW AND FOLLOW THE SAFETY AND OPERATING      INSTRUCTIONS CONTAINED IN THE TADANO/FAUN      MANUALS</li> <li>- YOU KNOW AND UNDERSTAND LOCAL WORKPLACE      RULES AND OSHA RECOMMENDATIONS</li> <li>- AN UNTRAINED OPERATOR SUBJECTS HIMSELF AND OTHERS      TO DEATH OR SERIOUS INJURY</li> </ul> <p>7757347</p> <p>123</p>	<p><b>DANGER</b></p> <p>ELECTROSHOCK HAZARD      CAN CAUSE SEVERE INJURY OR DEATH.      WHEN OPERATING THIS CRANE, ALWAYS WEAR YOUR SAFETY BELT      AND ALWAYS WEAR YOUR SAFETY SHOES TO PREVENT INJURY      FROM FALLING. ALWAYS WEAR YOUR SAFETY SHOES TO PREVENT INJURY      FROM FALLING. ALWAYS WEAR YOUR SAFETY SHOES TO PREVENT INJURY      FROM FALLING.</p>  <p>NEVER OPERATE CRANE AND THEN CLIMB UPON OR      STAND ON ANY PART OF CRANE OR BOOM. ALWAYS      WEAR YOUR SAFETY BELT AND ALWAYS WEAR YOUR SAFETY SHOES      TO PREVENT INJURY FROM FALLING. ALWAYS WEAR YOUR SAFETY      SHOES TO PREVENT INJURY FROM FALLING. ALWAYS WEAR YOUR      SAFETY SHOES TO PREVENT INJURY FROM FALLING.</p> <p><b>DANGER</b></p> <p>THIS MACHINE IS NOT DESIGNED TO BE OPERATED WITHOUT      THE PINS AND ROPS. ALWAYS WEAR YOUR SAFETY BELT AND ALWAYS      WEAR YOUR SAFETY SHOES TO PREVENT INJURY FROM FALLING.      ALWAYS WEAR YOUR SAFETY SHOES TO PREVENT INJURY FROM      FALLING. ALWAYS WEAR YOUR SAFETY SHOES TO PREVENT INJURY      FROM FALLING.</p>  <p>7757348</p> <p>124</p>	 <p><b>WARNING</b></p> <p>HAZARD      CAN CAUSE INJURY      DO NOT MOUNT OR CLIMB ON      CRANE WHILE OPERATING</p> <p>7757349</p> <p>125</p>	 <p><b>WARNING</b></p> <p>HAZARD      CAN CAUSE INJURY      DO NOT MOUNT OR CLIMB      ON BOOM JIB OR OUTRIGGER</p> <p>7757350</p> <p>126</p>
 <p><b>CAUTION</b></p> <p>DO NOT      STUMBLE OVER      PROJECTION</p> <p>7757351</p> <p>127</p>	 <p><b>WARNING</b></p> <p>DO NOT REMOVE      RADIATOR CAP      WHEN ENGINE IS HOT.</p> <p>7757352</p> <p>128</p>	<p><b>WARNING</b></p> <p>HAZARDOUS CONDITION      CAN CAUSE SEVERE INJURY      DO NOT REMOVE JIB PIVOT      PINS AT BOOM HEAD UNTIL      JIB IS PINNED TO STOWING      BRACKET</p> <p>7757353</p> <p>129</p>	 <p><b>WARNING</b></p> <p>AUTOMATIC FAN START      KEEP HANDS AWAY      STOP ENGINE TO SERVICE</p> <p>7757354</p> <p>130</p>



































































DECAL KIT "USA"  
 SCHILDERSATZ "USA"  
 JEU DE PLAQUES "USA"

from No / up to No  
 WFN5RUD###2029116  
 WFN5RUD###2029181

Figure  
 Bild 99707785896  
 Figure

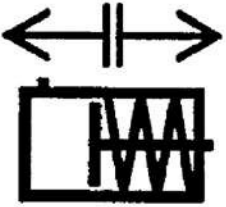
**TADANO**  
 2830-06

 <p><b>DANGER</b></p> <hr/> <p>HAZARDOUS OPERATION CAN RESULT IN SEVERE INJURY OR DEATH.      DO NOT LIFT PERSONNEL REFER TO ANSI B30.56-1991, PARA 5-3.2.2 FOR INSTRUCTIONS.</p> <p style="text-align: right;">7757270</p> <p style="text-align: center;">131</p>	 <p style="text-align: right;">132</p>	<p>BUBBLE MUST BE      IN THE CENTER      ( SEE OPERATORS MANUAL )</p> <p style="text-align: right;">7757298</p> <p style="text-align: center;">133</p>																					
		 <p><b>CAUTION</b></p> <hr/> <p>LOW CLEARANCE      BE AWARE OF OVER HEAD OBSTRUCTION</p> <p style="text-align: right;">7757366</p> <p style="text-align: center;">140</p>	<p>7757310</p> <p style="text-align: center;"><b>HAND SIGNALS</b></p> <table border="1" style="width: 100%; text-align: center;"> <tr> <td> HOIST</td> <td> LOWER</td> <td> USE MAIN HOIST</td> <td> USE WHIPLINE <small>(Over Lifting Point)</small></td> </tr> <tr> <td> RAISE BOOM</td> <td> LOWER BOOM</td> <td> MOVE SLOWLY</td> <td> RAISE THE BOOM AND LOWER THE LOAD</td> </tr> <tr> <td> LOWER THE BOOM AND RAISE THE LOAD</td> <td> SWING</td> <td> STOP</td> <td> EMERGENCY STOP</td> </tr> <tr> <td> TRAVEL</td> <td> CLOSE EVERYTHING</td> <td> TRAVEL <small>( ONE TRACK )</small></td> <td> TRAVEL <small>( ONE TRACK )</small></td> </tr> <tr> <td> EXTEND BOOM</td> <td> RETRACT BOOM</td> <td> EXTEND BOOM <small>( ONE HAND )</small></td> <td> RETRACT BOOM <small>( ONE HAND )</small></td> </tr> </table> <p style="text-align: center;">141</p>	 HOIST	 LOWER	 USE MAIN HOIST	 USE WHIPLINE <small>(Over Lifting Point)</small>	 RAISE BOOM	 LOWER BOOM	 MOVE SLOWLY	 RAISE THE BOOM AND LOWER THE LOAD	 LOWER THE BOOM AND RAISE THE LOAD	 SWING	 STOP	 EMERGENCY STOP	 TRAVEL	 CLOSE EVERYTHING	 TRAVEL <small>( ONE TRACK )</small>	 TRAVEL <small>( ONE TRACK )</small>	 EXTEND BOOM	 RETRACT BOOM	 EXTEND BOOM <small>( ONE HAND )</small>	 RETRACT BOOM <small>( ONE HAND )</small>
 HOIST	 LOWER	 USE MAIN HOIST	 USE WHIPLINE <small>(Over Lifting Point)</small>																				
 RAISE BOOM	 LOWER BOOM	 MOVE SLOWLY	 RAISE THE BOOM AND LOWER THE LOAD																				
 LOWER THE BOOM AND RAISE THE LOAD	 SWING	 STOP	 EMERGENCY STOP																				
 TRAVEL	 CLOSE EVERYTHING	 TRAVEL <small>( ONE TRACK )</small>	 TRAVEL <small>( ONE TRACK )</small>																				
 EXTEND BOOM	 RETRACT BOOM	 EXTEND BOOM <small>( ONE HAND )</small>	 RETRACT BOOM <small>( ONE HAND )</small>																				
 <p style="text-align: right;">7741365</p> <p>RELEASING OF      SPRING-LOADED CYL.</p> <p style="text-align: right;">142</p>	<p>140°F ———</p> <p>104°F ———</p> <p>68°F ———</p> <p>32°F ———</p> <p style="text-align: right;">7741388</p> <p style="text-align: center;">143</p>	 <p><b>WARNING</b></p> <p>DO NOT TOUCH      THE FAN</p> <p style="text-align: right;">7748462</p> <p style="text-align: center;">145</p>																					

DECAL KIT "USA"  
SCHILDERSATZ "USA"  
JEU DE PLAQUES "USA"

from No / up to No  
WFN5RUD###2029116  
WFN5RUD###2029181

Figure  
Bild 99707785896  
Figure

 **TADANO**  
2830-06

